



IK-12 MAX3

The Portable Multi-purpose Carriage

Features and Benefits

- **Maximum reliability in most heavy-duty environment**
Not affected by intense heat and fluctuating voltage, the maximum driving mechanism ensures steady traveling
- **Double Cone Steplless Drive System**
Ensures extremely smooth speed transition, speed micro-adjustment and constant travel speed, which provides the IK-12 Max3's famous sharp, fine cuts.
- **Choice of accessory and options**
Features wide variety of options that makes the machine suitable to achieve various cutting needs.
- **Selectable torch set and rails**
Each torch set is specially designed for the purpose, ensuring the maximum results.
- **Versatility**
Ready for oxyfuel cutting, plasma cutting, or welding

The **IK-12 Max3** is an incredibly robust tractor, which has been highly rated among the portable oxy-fuel cutting machines. Body structure is systematized to apply to different types of work and meet the needs of plasma cutting and automatic welding. Each component is functionally worked out as independent units, selection and assortment are at the customer's disposal to create the system needed for the requirement.

Enjoy the maximum efficiency, versatility and productivity with the **IK-12 Max3**.

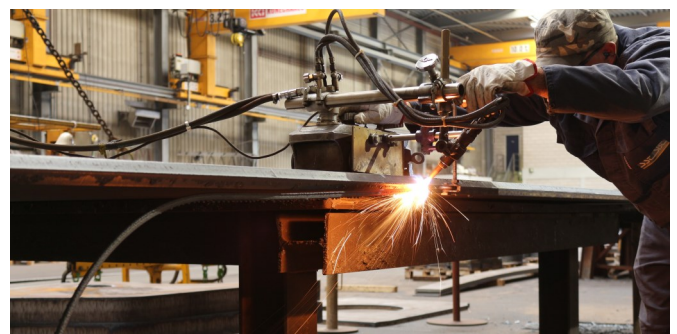

Carriage

The Original.

Since 1951 when the first model was released in Japan, Koike IK-12 series have been serving professionals who demand the highest quality in plate cutting.

Today, the state-of-the-art 6th generation, **IK-12 Max3** is equipped with double cone stepless drive system to maximize the reliability in cutting. Electrical and mechanical components, grease, soldering and wiring are carefully selected to ensure long service life in the most heavy-duty working environment.

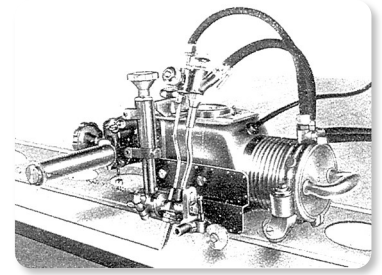

The first generation. Japan, 1951

Double Cone Stepless Drive System

Speed control mechanism of **IK-12 Max3** has adopted Double Cone Stepless Drive System, developed by KOIKE, which functions with a condenser motor rotating at constant speed (1500 rpm @50Hz) to prevent heat and voltage problems from occurring.

Because no reduction gear is employed in the mechanism, any knocking from backlash, noise or vibration does not take place. 50kg maximum loading weight with entire use of heat-resisting grease, high temperature soldering and minimal electrical component, **IK-12 Max3** is reliable and durable for long continuous operation.

Also the condenser motor rotating at a constant low speed prolongs the service life of bearing and maintains the machine condition for a long period of time.

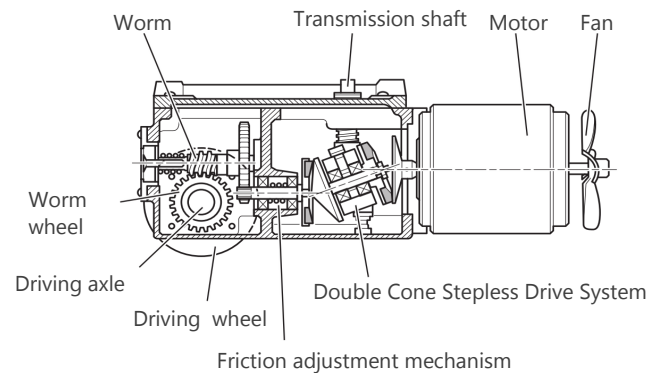

Machine selections

There are three different models available with **IK-12 Max3**.

- | | | | |
|-----------------|------------|-------------------------------------|---|
| ■ IK-12 Max3 | Standard | 80 - 800 mm/min. | Suitable for most cutting and welding applications. |
| ■ IK-12 Max3-S | High Speed | 80 - 800 mm/min, 240 - 2400 mm/min. | Dual speed range. Suitable for plasma. |
| ■ IK-12 Max3-ML | Slow Speed | 40 - 400 mm/min. | Suitable for thick plate cutting and bevelling. |

(speeds indicated above are with 50 Hz power supply)

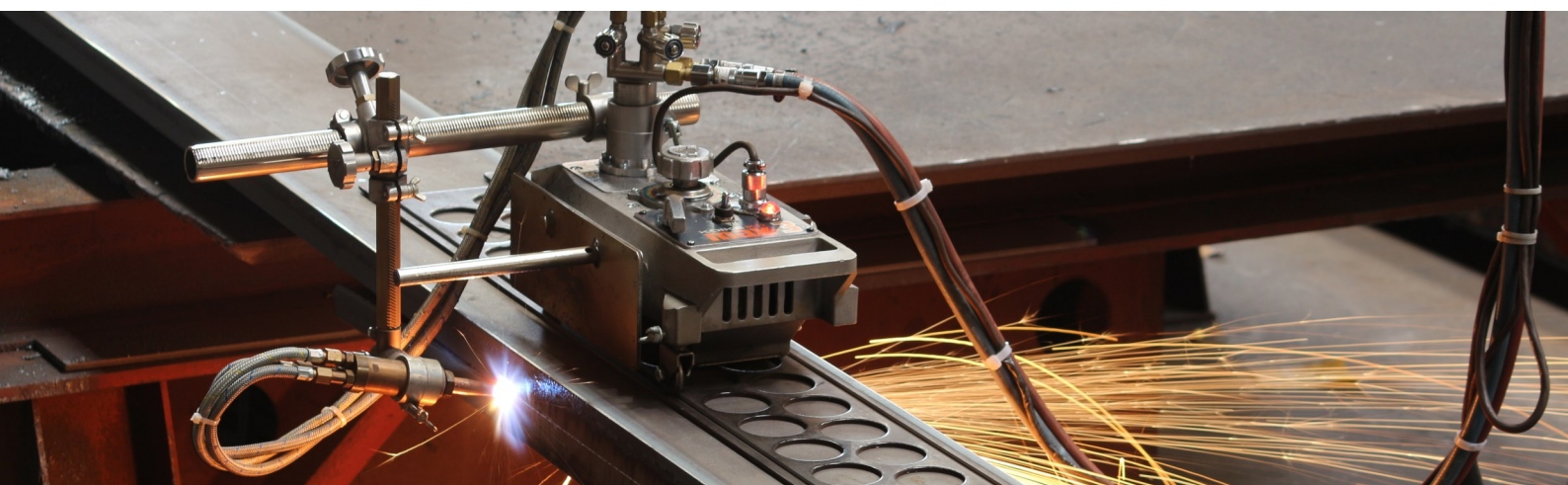

Torch set

Oxy-fuel cutting torch set

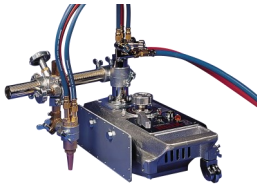

S-100 Torch Set
 ■ Standard 1 torch unit



SP-100 Torch Set
 ■ 1 torch unit with mechanical automatic torch height control

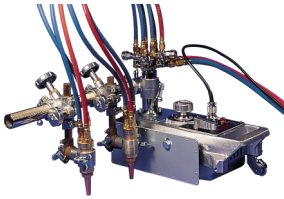

S-200 Torch Set
 ■ Standard 2 torch unit

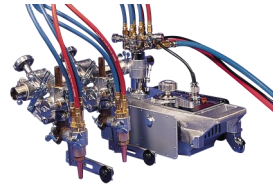

SP-200 Torch Set
 ■ 2 torch unit with mechanical automatic torch height control on each torch unit

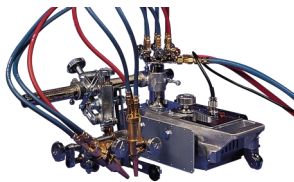

SP-300 Torch Set
 ■ 2 torch unit with mechanical automatic torch height control
 ■ Maintains angle of 2 torches for accurate Y and X bevel cuts

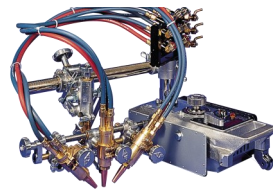

SP-400 Torch Set
 ■ 3 torch unit with mechanical automatic torch height control
 ■ Maintains angle of 3 torches for accurate Y, X, and K bevel cuts

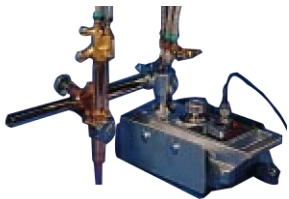

L-100 Torch Set
 ■ Heavy duty torch designed to cut up to 300 mm plate thickness.
 ■ Water cooled

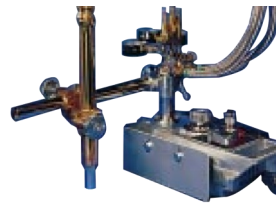

EPOCH-300/600 Torch Set
 ■ A safe, flashback-free out mixing torch, designed to cut up to 600mm plate thickness.
 ■ Water cooled
 ■ For propane gas

Torch set	S-100	SP-100	S-200	SP-200	SP-300	SP-400	L-100	EPOCH-300	EPOCH-600
Stock No.	90036	90038	90037	90039	90040	90041	90042	90043	90046
Max. cutting thickness (1 torch)	150 mm	150 mm	150 mm	150 mm	100 mm	100 mm	300 mm	300 mm	600 mm
Number of torch	1	1	2	2	2	3	1	1	1
Gas mixing	Tip mixing	•	•	•	•	•	•	-	-
	Out mixing	-	-	-	-	-	-	•	•
Mechanical auto height control	-	•	-	•	•	•	-	-	-
Standard pipe bar length (mm)	350	350	500	500	500	500	500	500	500
Vertical torch stroke (mm)	80	120	80	120	120	120	-	-	-
Cutting type		•	•	•	•	•	•	•	•
		•	•	•	•	•	•	•	•
		-	-	•	•	-	-	-	-
		-	-	•	•	-	-	-	-
		-	-	•	•	•	•	-	-
		-	-	•	•	•	•	-	-
		-	-	-	-	-	•	-	-
Optional torch accessories									
Long pipe bar	•	•	•	•	•	•	•	•	•
Long slide bar	•	•	•	•	-	-	-	-	-
Snap valve	•	•	•	•	-	-	-	-	-
Pre-set stop valve	•	•	•	•	-	-	-	-	-

• : possible



S-100 Torch set



S-200 Torch set with Long slide bar option



S-100 with Long slide bar option



S-100 with Long slide bar and Bevel attachment option



EPOCH Torch set with Heavy duty rail

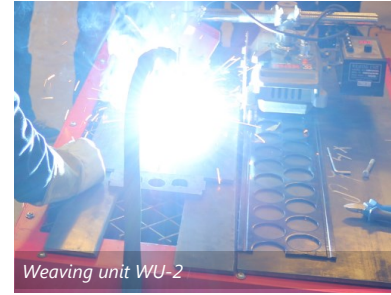

Weaving unit WU-2



S-100 Torch set



S-100 Torch set with Long slide bar option



S-100 Torch set with Long slide bar and Guide roller option

Plasma cutting, welding torch set and related accessories



IK-12 Plasma Torch Set

- For 35mm torch diameter
- Torch set only
- Plasma ON/OFF Remote controller sold separately (FR-III Controller)



MP-100 Welding Torch Set

- For straight line butt welding
- Torch set only



Weaving unit WU-2

- Pendulum weaving unit for IK-12 Max3, including weaving unit, pipe bar and controller



FR-III Controller

- For Plasma cutting or welding
- Arc delay function
- Controls IK-12 Max3 and power source simultaneously

Torch set / Controller		IK-12 Plasma	MP-100 Welding	Weaving Unit WU-2	FR-III Controller
Stock No.		90045	BUA31301	90219	61003427 (220V) BUB01553 (110V)
Working voltage	AC 220V	-	-	-	•
	AC 110 V	-	-	•	•
Torch clamp diameter		Ø 35 mm	Ø 16 - 20 mm	Ø 16 - 20 mm	-
Pipe bar length (mm)		500	350	500	-
Application	Plasma cutting	•	-	-	•
	Continuous Welding	-	•	•	•
	Weaving welding	-	-	•	-

• : possible

Accessories

Optional accessories



Standard rail 1800 mm

- Extendable 1800 mm rail
- Built of special steel to ensure long life time



Circle cutting rail

- Cutting diameter $\varnothing 40 - 360$ mm (inside); $\varnothing 770 - 1150$ mm (outside)
- Counter weight recommended



Heavy duty rail 1800 mm

- Extendable, robust structured rail that does not bend
- Recommended when cutting thick plate over 150 mm



Circle cutting attachment

- Cutting diameter $\varnothing 400 - 2400$ mm



Long slide bar

- Extends torch up/down stroke, used when cutting from the side of the plate
- Available in different lengths



Plate edge guide roller

- Enables bevel cuts without rail by tracking plate edge
- For straight line cutting only

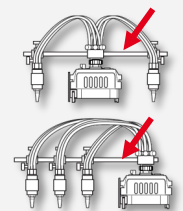

Long pipe arm

- Long pipe arm to enable different torch positioning
- Available in different lengths

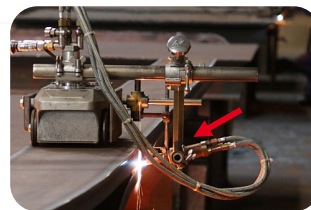

Snap valve B-type

- Single action gas on/off
- Increases productivity by eliminating flame adjustments each time after cut



Preset stop valve

- Single actin gas on/off
- 2 models; single or two torches



Torch bevel attachment

- Accurate bevel cutting with angle indicator
- Cuts bevel without tilting the torch



Twin torch attachment

- Enables 2-torch parallel cutting by attaching to a torch.
- Torch distance 30 - 300 mm



Flashback arrestor hose set

- A set of flashback arrestors with metal bladed hose
- Includes 3x flashback arrestors and 3x metal bladed hoses



Rail fixing magnet

- Holds the rail onto the place



MIG torch holder

- Simple welding torch holder, clamp diameter $\varnothing 16 - 20$ mm
- Fits on S-100 or SP-100 torch set by replacing oxy-fuel torch



Extended stand

- 105mm long stand

Accessory	Stock #	
IK-12 Standard rail 1800 mm	30400	
IK-12 Heavy duty rail 1800 mm	90044	
IK-12 Max3 Circle cutting rail	30410	
Circle cutting attachment	90100	
Plate edge guide roller	T60038959	
Preset stop valve	1 torch	80518
	2 torch	61003543
Snap valve B-type	80512	
Torch bevel attachment	ON002	
Twin torch attachment	ON001	
Rail fixing magnet	D6010	
MIG torch holder	61000676	
Transformer AC230V - 42V	222.002.207	
Transformer AC230V - 110V	90100	

Accessory	Stock #	
Long slide bar	145 mm (standard)	30390
	250 mm	30430
	300 mm	30431
	400 mm	30422
	350 mm	30300
Long pipe arm	500 mm	30321
	1000 mm	30425
	1500 mm	30427
	2500 mm	30429
	80 mm (standard)	30204
Stand	105 mm	30378
	600 mm hoses	on request
Flashback arrestor hose set	900 mm hoses	on request

Type and Specification

Specifications

	IK-12 Max3 Standard	IK-12 Max3-S	IK-12 Max3-ML	
Traveling speed	@50 Hz	80 - 800 mm/min	240 - 2400 mm/min	40 - 400 mm/min
	@60 Hz	100 - 1000 mm/min	100 - 1000 mm/min 300 - 3000 mm/min	50 - 500 mm/min
Input power	AC 220V / AC 110V / AC 42V (+/- 10%)			
Cutting thickness	Depends on torch set			
Drive system	Double Cone Stepless Drive System			
Motor	Condenser-induction			
Machine construction	Aluminium die cast body			
Gear box	Closed gear box, highly resistant against heat and dust			
Max. loading weight	50 kg			
Machine dimension	L430 x W220 x H215 mm			
Weight	10 kg	11 kg	11 kg	

Types

Carriage Model	Stock #	
IK-12 Max3 machine body	42V	90029
	110V	90028
	220V	90027
IK-12 Max3-S machine body	42V	90056
	110V	90057
	220V	90026
IK-12 Max3-ML machine body	220V	90033
	42V	90030

Scope of delivery

Scope of delivery
Machine body
Power cable
Tip support
Hexagon bolt (2pcs)
Operation manual



KOIKE Portable Machines and Gas Equipment v.1.04 © 2016 Koike Europe B.V. Technical changes as well as errors and printing mistakes are reserved. 11/2016

Headquarter:

Koike Europe B.V.

Grote Tocht 19
1507 CG Zaandam
The Netherlands

Tel +31-(0)75 - 612 - 7227
Fax +31-(0)75 - 670 - 2271
info@koike-europe.com
www.koike-europe.com

Koike Europe B.V.

Germany Branch Office

Im Löchel 2
35423 Lich-Eberstadt
Deutschland

Tel +49-(0)6004 - 91 - 6930
Fax +49-(0)6004 - 91 - 6931- 01
info.germany@koike-europe.com
www.koike-europe.com

Koike France S.a.r.l.

Espace Mercure
Z.A.E. Les Dix Muids
59770 Marly
France

Tel +33-32730-4343
Fax +33-32730-1250
info@koike-europe.com
www.koike-europe.com

Koike Italia Srl

Via Papa Giovanni XXIII, n 45
20090 - RODANO (MILANO)
Italy

Tel +39-02953 - 28 - 717
Fax +39-02739 - 60 - 447
info@koike-europe.com
www.koike-europe.com

Koike Middle East FZE

SAIF Zone Sharjah-UAE
P.O. Box 122978
United Arab Emirates

Mobile +971561177615 /
+971566453803
Fax +9716-5312805
b.pandey@koike-europe.com
www.koike-europe.com